

西立面图

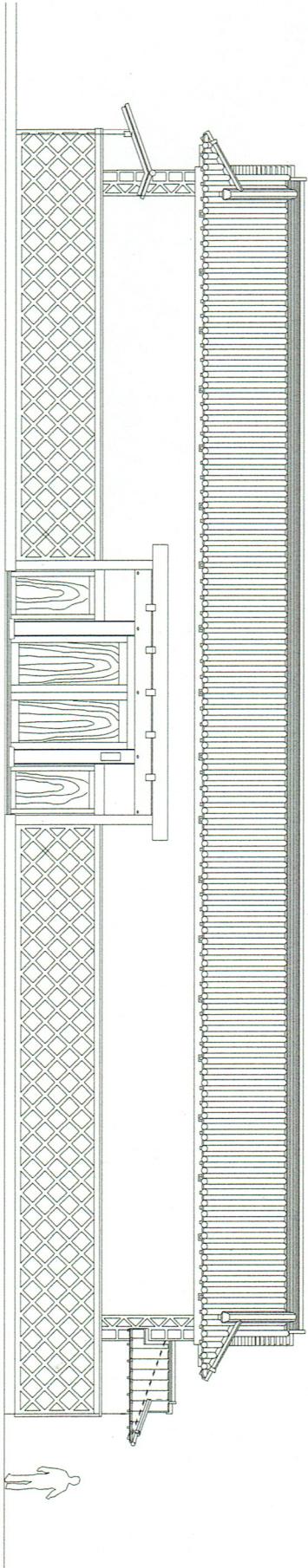

东立面图

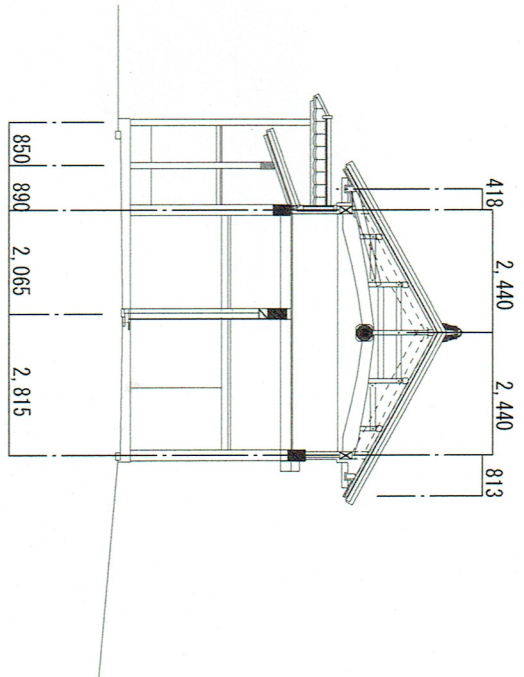



断面图

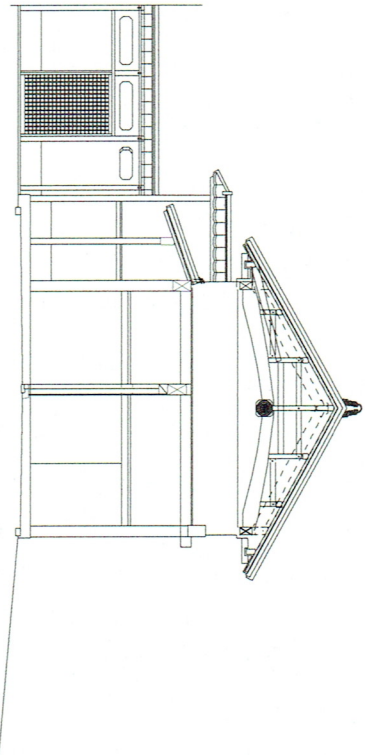

断面图

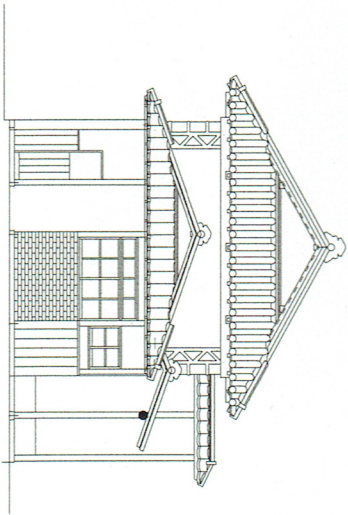

北面立面图

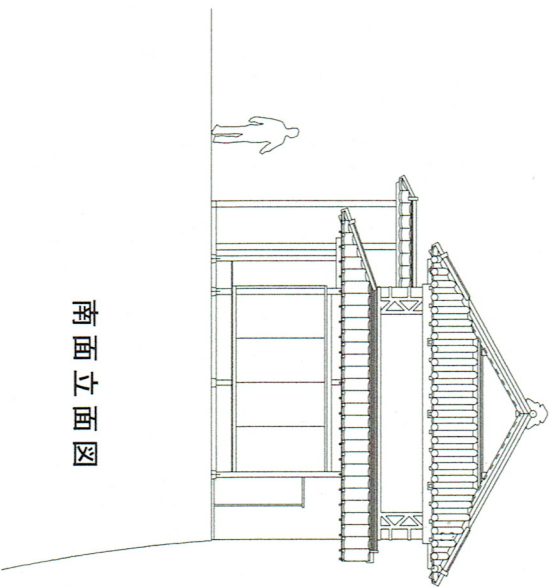

南面立面图

主屋

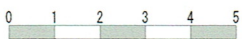
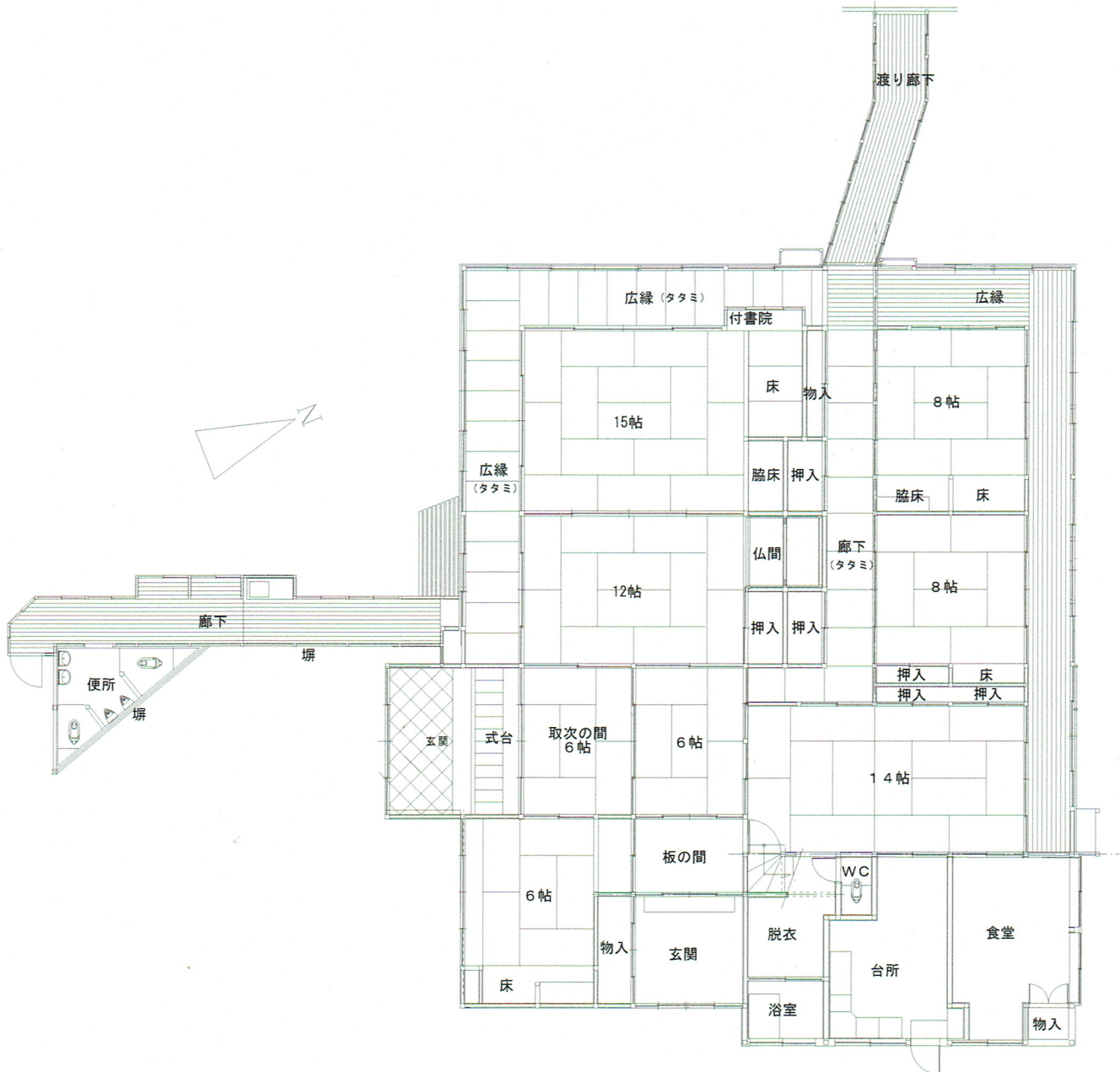
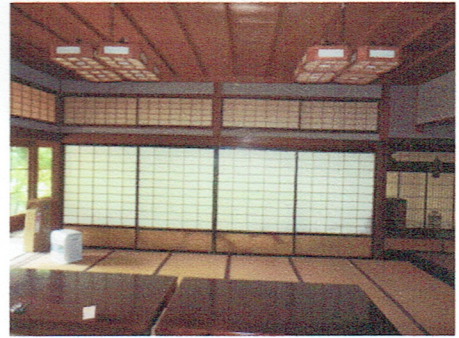

主屋 1階平面図

主屋

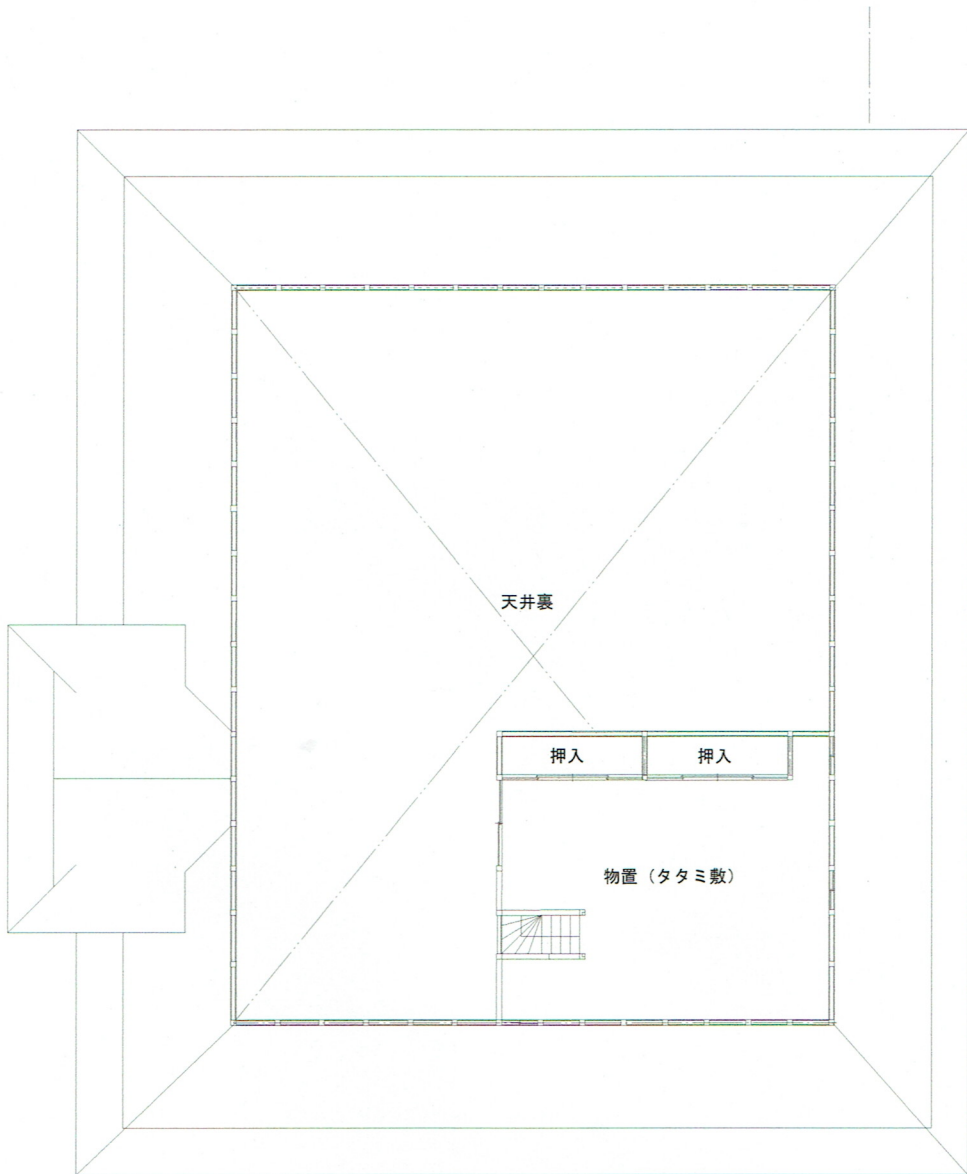

主屋 1階平面図

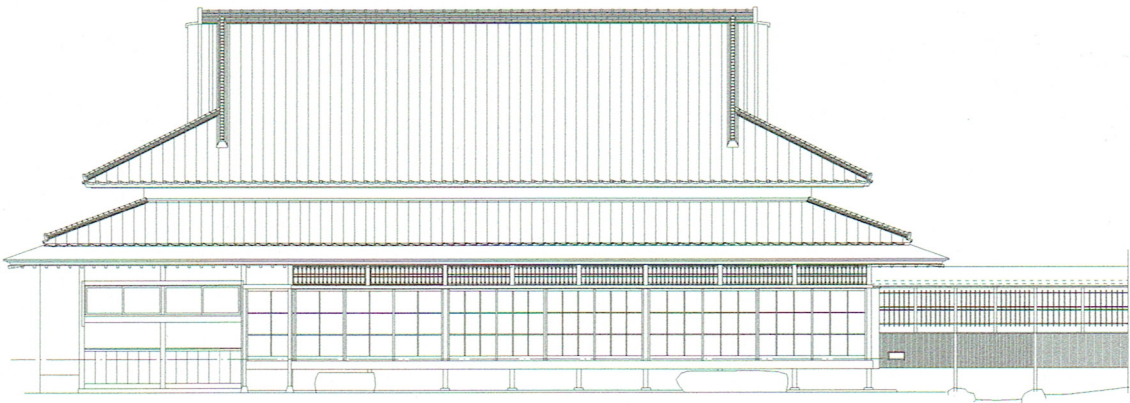

北立面图

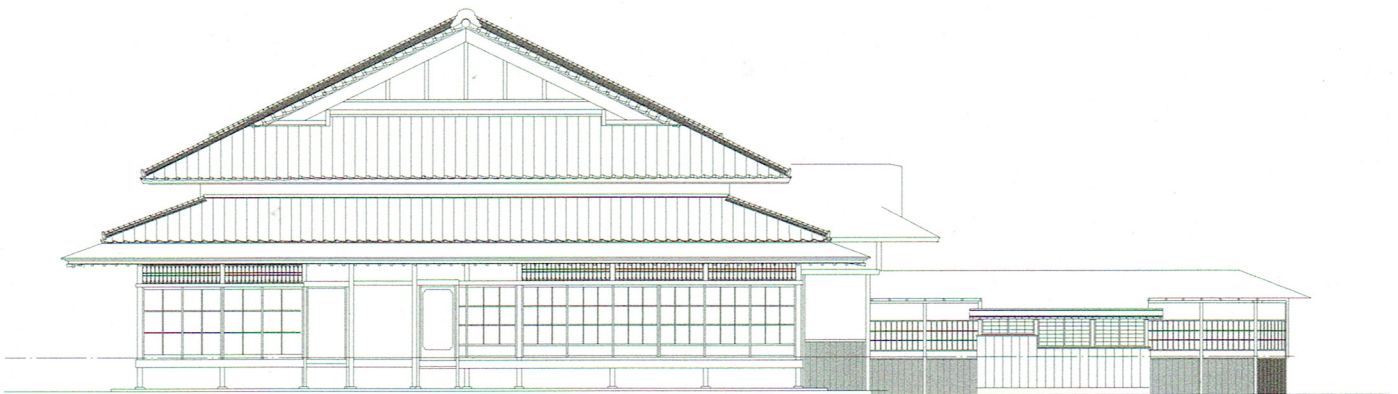

西立面图

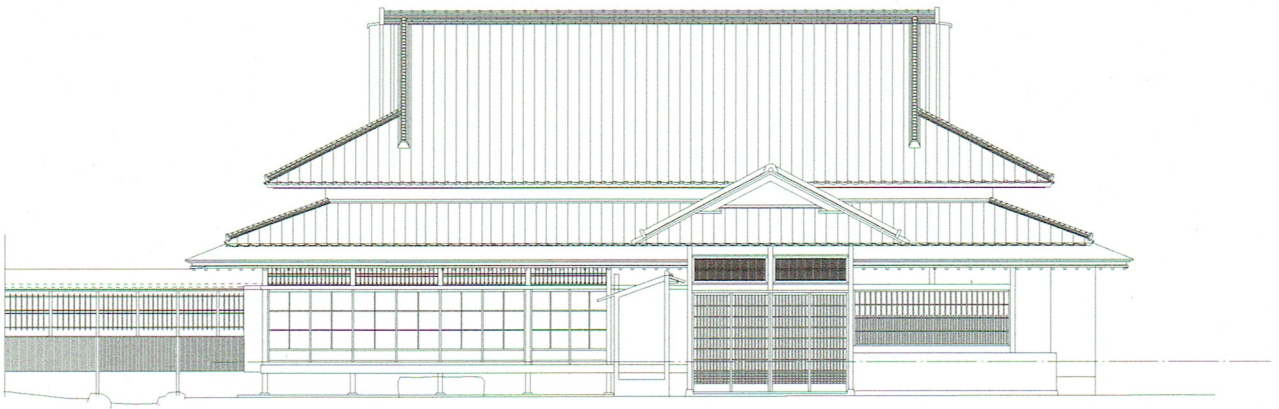

南立面图



東立面图

離丸 - 内蔵

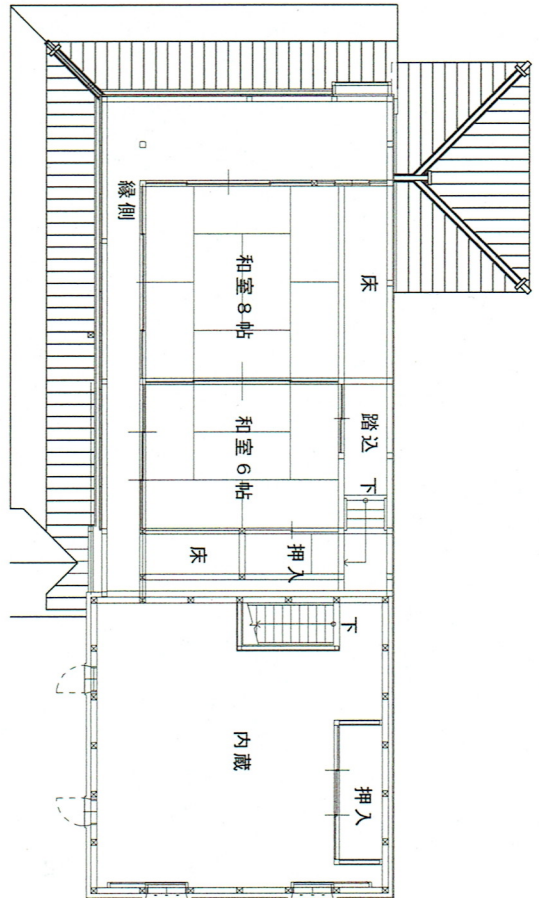

2階平面図

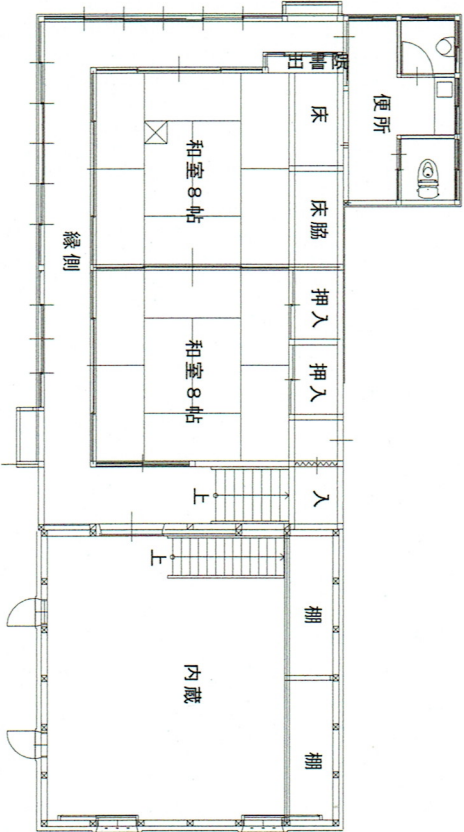

1階平面図



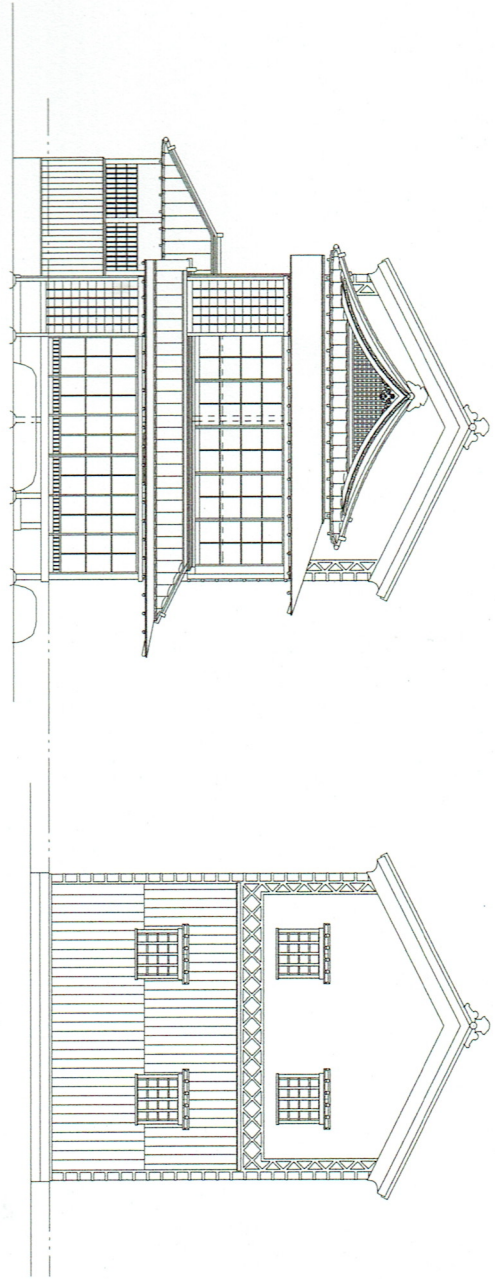

南立面图

北側立面图

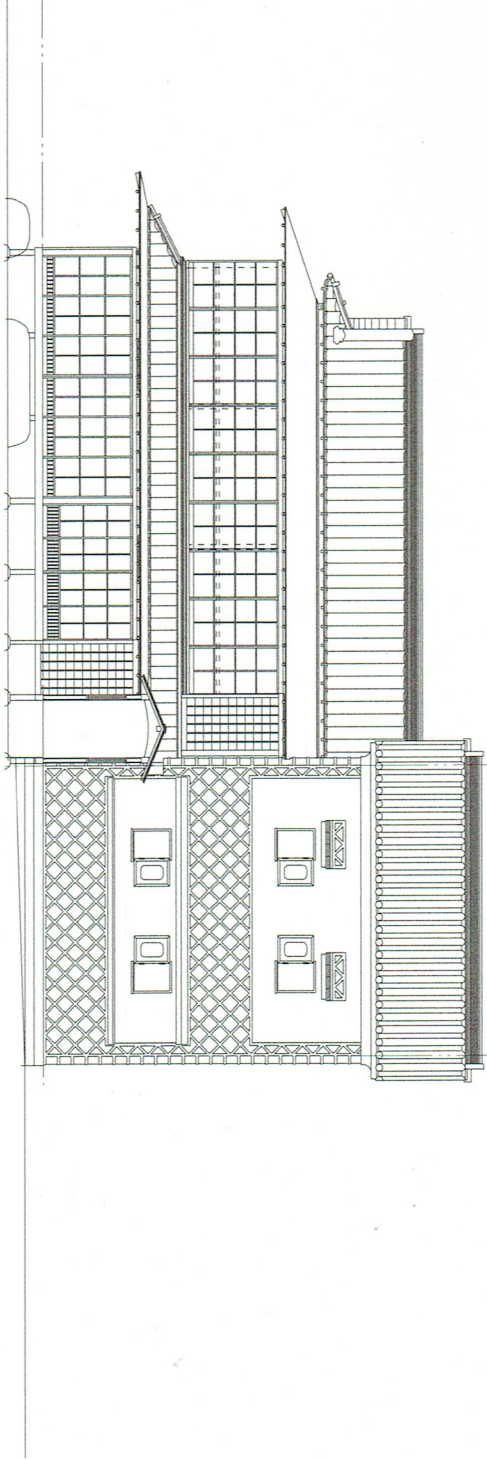

東立面图



米蔵

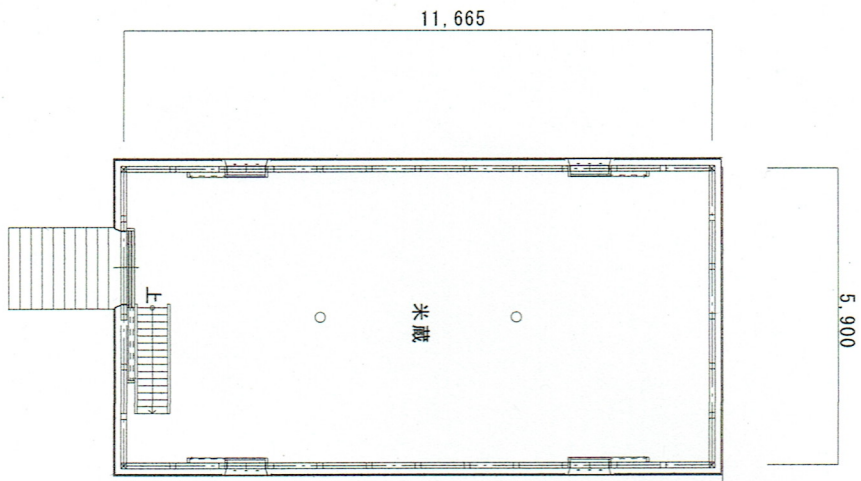

1階平面図

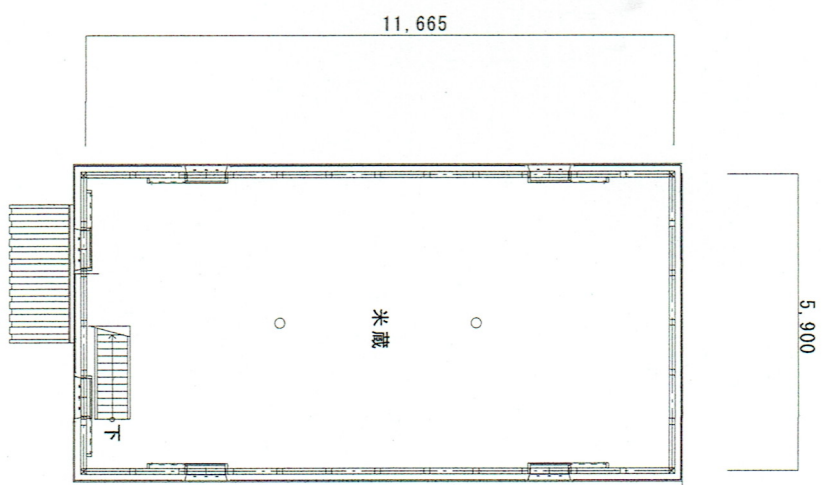

2階平面図

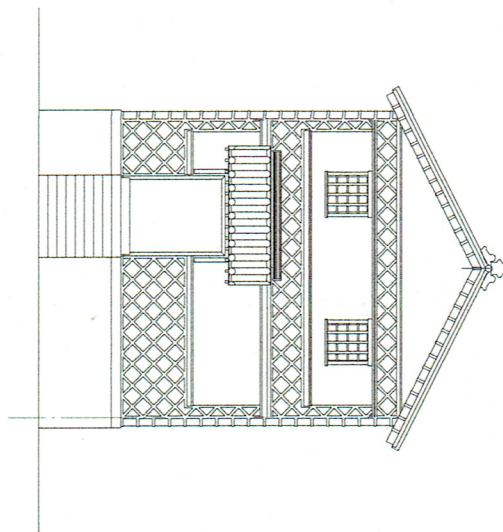

東立面図



中蔵

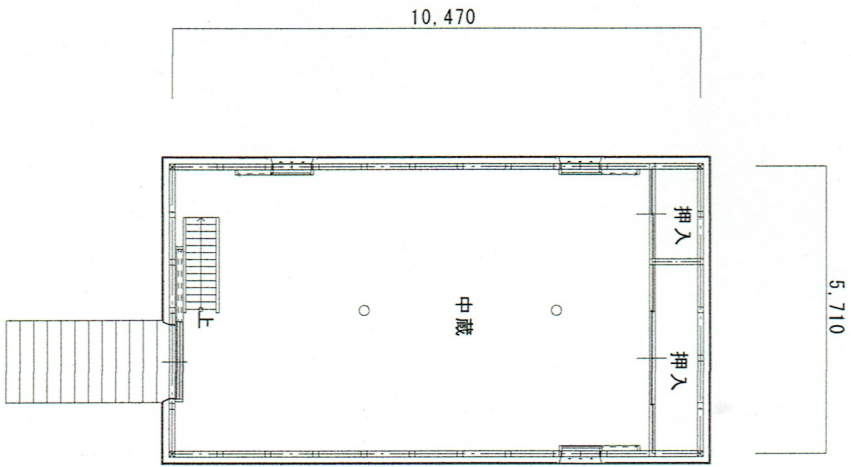

1階平面図

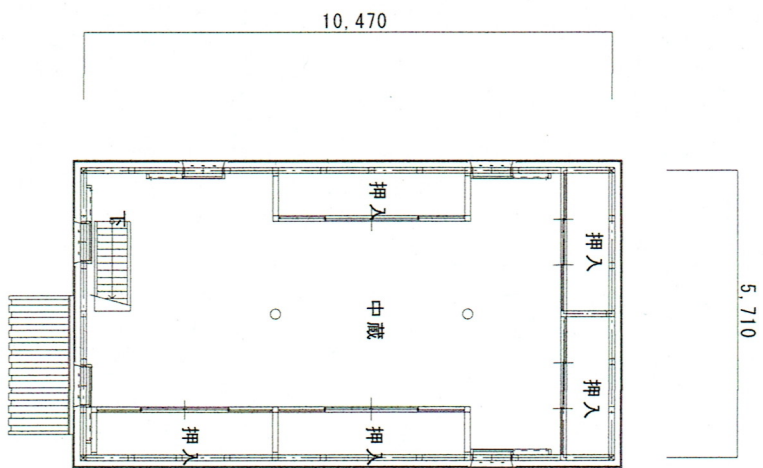

2階平面図

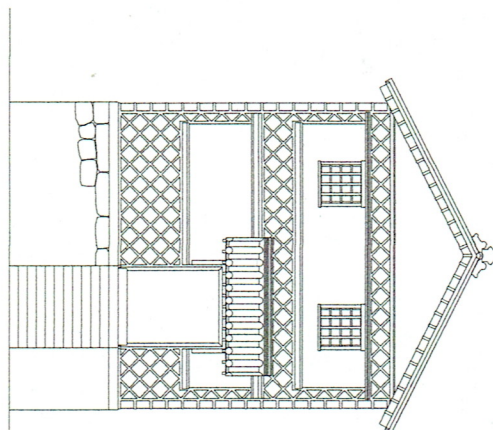

東立面図

